

Proximity switch SMT-10M

FESTO

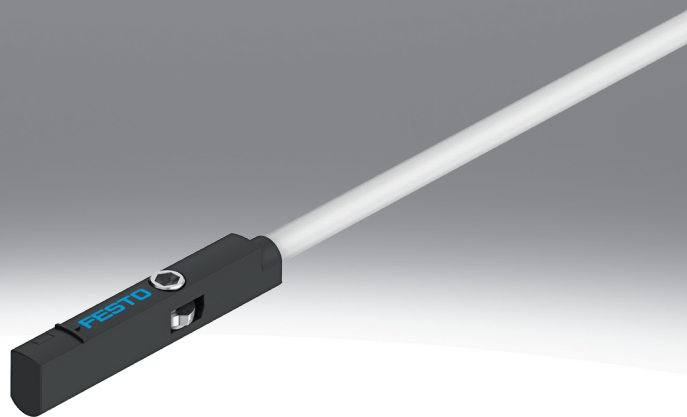

Characteristics

Product segmentation



Festo Core Range

Solves the majority of your automation tasks

With the Festo Core Range, we have selected the most important products and functions from our broad product catalogue, and added the quickest delivery. The Core Range offers you the best value with the expected high Festo quality.

Quickest delivery, worldwide – wherever, whenever

- Expected high Festo quality
- Easy and fast to select

Ordering data - modular system

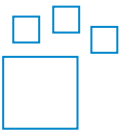

Configurable product

This product and all its product options can be ordered online via the configurator.

Type code

001	Series	
SMT	Proximity sensor	
002	Design type	
10M	For C-slot, inserted in slot from above	
003	Switching output	
NS	3-wire NPN N/O contact	
PS	3-wire PNP N/O contact	
ZS	2-wire PNP N/O contact	
004	Rated operating voltage	
24V	24 V	
005	Cable characteristic	
E	Suitable for energy chains/robot applications	

006	Cable length [m]	
	0.2 ... 30 m	
0,3	0.3 m	
2,5	2.5 m	
007	Display	
L	LED	
008	Cable outlet	
Q	Transverse	
L	Longitudinal	
009	Cable identification	
	With label holder	
N	Without label holder	
010	Connection technology	
OE	Open end	
M8	M8, snap-on flange	
M8D	M8, rotatable thread	
M12	M12, rotatable thread	

Datasheet

General technical data			
Electrical connection 1, connector system	M12x1, A-coded to EN 61076-2-101	M8x1, A-coded, to EN 61076-2-104	Open end
Design	For C-slot		
Conforms to standard	EN 60947-5-2		
Approval	RCM trademark		
KC mark ¹⁾	–		
KC Approval No. EMC/Radio ²⁾	–		
CE mark (see declaration of conformity) ³⁾	To EU EMC Directive, In accordance with EU RoHS Directive		
CE marking (see declaration of conformity) ⁴⁾	To UK instructions for EMC, To UK RoHS instructions		
Special characteristics	Oil resistant		
Note on materials	RoHS-compliant, Free of halogen		
Instructions on use	https://www.festo.com/Drive-Sensor-Overview		
LABS (PWIS) conformity	VDMA24364-B2-L		
Suitability for the production of Li-ion batteries	Metals with more than 1% copper, zinc or nickel by mass are excluded from use. Exceptions are nickel in steel, chemically nickel-plated surfaces, printed circuit boards, cables, electrical plug connectors and coils		
Cleanroom class	Class 4 according to ISO 14644-1		
Corrosion resistance class CRC	2 - Moderate corrosion stress		3 - high corrosion stress

1) Only for SMT-10M-PS-24V-E-0.3-L-M12

2) For information about the area of use, see the EC declaration of conformity at: www.festo.com/catalogue/smt → Support/Downloads.

If the devices are subject to usage restrictions in residential, commercial or light-industrial environments, further measures for the reduction of the emitted interference may be necessary.

3) For information about the area of use, see the EC declaration of conformity at: www.festo.com/catalogue/smt → Support/Downloads.

If the devices are subject to usage restrictions in residential, commercial or light-industrial environments, further measures for the reduction of the emitted interference may be necessary.

4) For information about the area of use, see the EC declaration of conformity at: www.festo.com/catalogue/smt → Support/Downloads.

If the devices are subject to usage restrictions in residential, commercial or light-industrial environments, further measures for the reduction of the emitted interference may be necessary.

Input signal/measuring element	
Measured variable	Position
Measuring principle	Magneto-resistive
Ambient temperature	-40 ... 70°C
Ambient temperature with moving cable	-20 ... 70°C

Switching output			
Switching output	NPN	PNP	Non-contacting, 2-wire
Electrical connection 1, connector system	M8x1, A-coded, to EN 61076-2-104, Open end	M12x1, A-coded to EN 61076-2-101, M8x1, A-coded, to EN 61076-2-104, Open end	Open end
Switching element function	N/O contact		
Repetition accuracy	0.2 mm		
Switch-on time	≤1.3 ms		≤1 ms
Switch-off time	4.2 ... 7.3 ms		≤1 ms
Max. switching frequency	130 Hz		150 Hz
Max. output current	100 mA		
Max. output current using mounting kits	50 mA		
Max. switching capacity DC	2.8 W		2.4 W
Max. switching capacity DC using mounting kits	1.5 W		1.2 W
Voltage drop	≤1.5 V	≤1.7 V	≤6 V

Output, additional data	
Short circuit current rating	yes
Overload protection	Available

Electronics			
Switching output	NPN	PNP	NPN, PNP, Non-contacting, 2-wire Non-contacting, 2-wire
Rated operational voltage DC	24 V		
Operational voltage range DC	5 ... 30 V		7 ... 30 V
Reverse polarity protection	For all electrical connections		

Datasheet

Electromechanics		
Electrical connection 1, connection type	Cable	Cable with plug
Electrical connection 1, connector system	Open end	M12x1, A-coded to EN 61076-2-101, M8x1, A-coded, to EN 61076-2-104
Electrical connection 1, number of connections/cores	2, 3	3
Electrical connection 1, type of mounting	–	Screw-type lock
Connection outlet orientation	In-line, Lateral	
Test conditions cable	Bending strength: to Festo standard, Test conditions on request, Torsional resistance: > 300,000 cycles, $\pm 270^\circ/0.1$ m, Energy chain: > 5 million cycles, bending radius 28 mm	
Cable length	2.5 m	0.3 m
Cable characteristic	Suitable for energy chains/robot applications	

Mechanics	
Type of mounting	Screw-clamped, Insertable in the slot from above
Max. tightening torque	0.4 Nm
Mounting position	optional
Material housing	PA-reinforced, High-alloy stainless steel
Material cable sheath	TPE-U(PUR)

Display/operation	
Switching status indication	Yellow LED

Immission/emission	
Ambient temperature with moving cable	-20 ... 70°C
Degree of protection	IP65, IP68

Dimensions

Dimensions – SMT-10M-...-L, outlet direction lengthwise connection

Download CAD data → www.festo.com

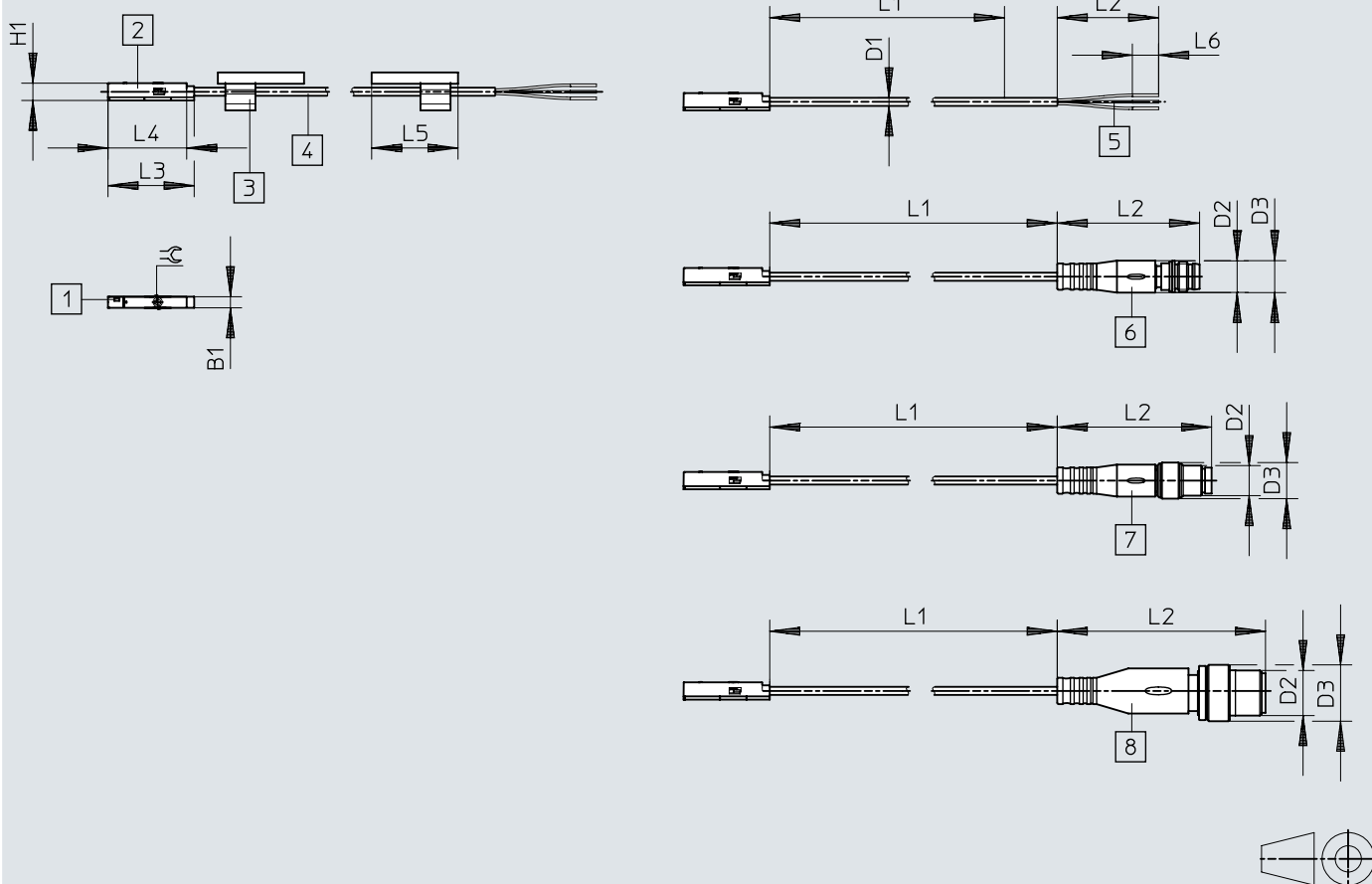

- [1] Yellow light emitting diode
- [2] SMT-10M
- [3] Inscription label holder
- [4] Connecting cables
- [5] Cable open end
- [6] Plug M8x1, snap collar
- [7] Plug M8x1, rotatable thread
- [8] Plug M12x1
- [9] L1 cable length

	B1	D1 ∅	D2	D3 ∅	H1	L2	L3	L4	L5	L6	L7	⊕
SMT-10M-...-OE	2,9	2,15	-	-	4,6	50	22,9	20,9	23	50	7	1,5
SMT-10M-...-M8D			M8x1	8,5		32,7					-	
SMT-10M-...-M8			M8x1	9,6		41,1					-	
SMT-10M-...-M12			M12x1	15		55,5					-	

Dimensions

Dimensions – SMT-10M-...-Q, outlet direction lateral connection

Download CAD data → www.festo.com

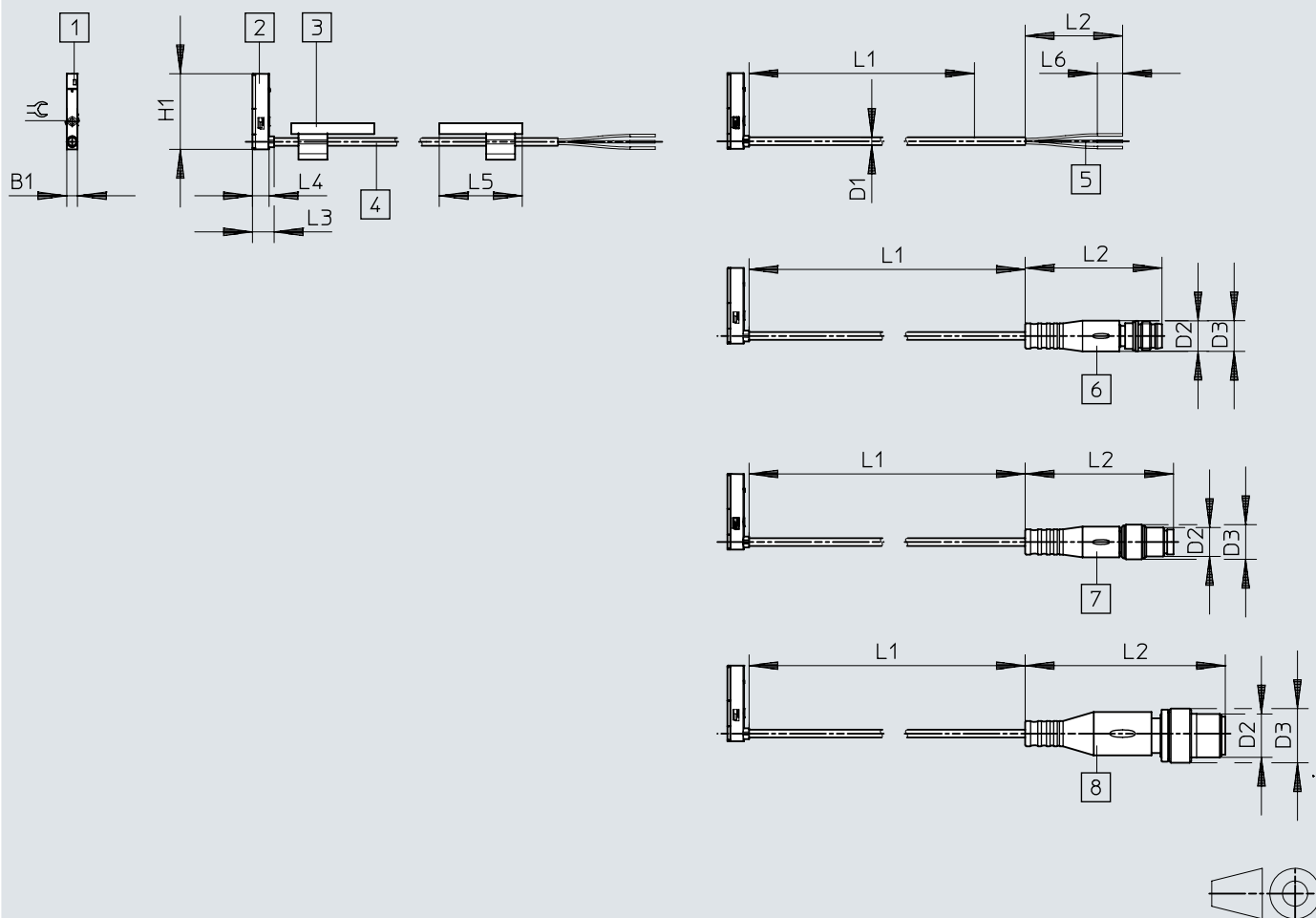

- [1] Yellow light emitting diode
- [2] SMT-10M
- [3] Inscription label holder
- [4] Connecting cables
- [5] Cable open end
- [6] Plug M8x1, snap collar
- [7] Plug M8x1, rotatable thread
- [8] Plug M12x1
- [9] L1 cable length

	B1	D1 ∅	D2	D3 ∅	H1	L2	L3	L4	L5	L6	L7	⊕
SMT-10M-...-OE	2,9	2,15	-	-	20,9	50	6	4,6	23	50	7	1,5
SMT-10M-...-M8D			M8x1	8,5		32,7					-	
SMT-10M-...-M8			M8x1	9,6		41,1					-	
SMT-10M-...-M12			M12x1	15		55,5					-	

Dimensions

Dimensions – Mounting SMBN-10

Download CAD data → www.festo.com

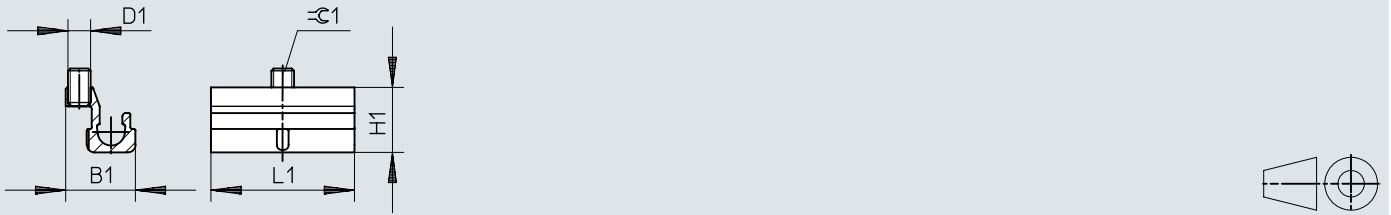

	D1	B1	H1	L1	$\varnothing 1$
SMBN-10	M3	9,3	8,6	19	1,5

Dimensions

Dimensions – Positioning element SMM

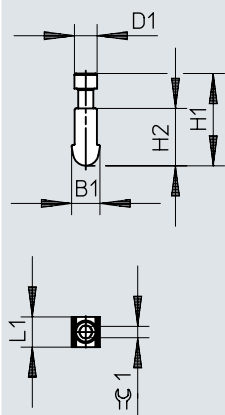
Download CAD data → www.festo.com

	B1	D1	H1	H2	L1	≈1
SMM-10	3,75	3,0	12,23	7,6	4,0	1,5

Ordering data

Ordering data					
	Switching output	Cable length	Product weight	Part no.	Type
	NPN	0.3 m	6.7 g	551380	SMT-10M-NS-24V-E-0,3-Q-M8D
		2.5 m	16.8 g	★ 551379	SMT-10M-NS-24V-E-0,3-L-M8D
				★ 551377	SMT-10M-NS-24V-E-2,5-L-OE
				551378	SMT-10M-NS-24V-E-2,5-Q-OE
	PNP	0.3 m	6.7 g	★ 551375	SMT-10M-PS-24V-E-0,3-L-M8D
				551376	SMT-10M-PS-24V-E-0,3-Q-M8D
		2.5 m	16.8 g	8152201	SMT-10M-PS-24V-E-0,3-L-M12
				551374	SMT-10M-PS-24V-E-2,5-Q-OE
	Non-contacting, 2-wire	14.6 g	★ 551373	SMT-10M-PS-24V-E-2,5-L-OE	
			551383	SMT-10M-ZS-24V-E-2,5-Q-OE	
★ 551382	SMT-10M-ZS-24V-E-2,5-L-OE				

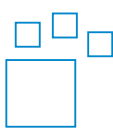
Ordering data – Modular product system				
	Design	Switching output	Part no.	Type
	For C-slot	NPN, PNP, Non-contacting, 2-wire	551372	SMT-10M

Peripherals

Peripherals overview

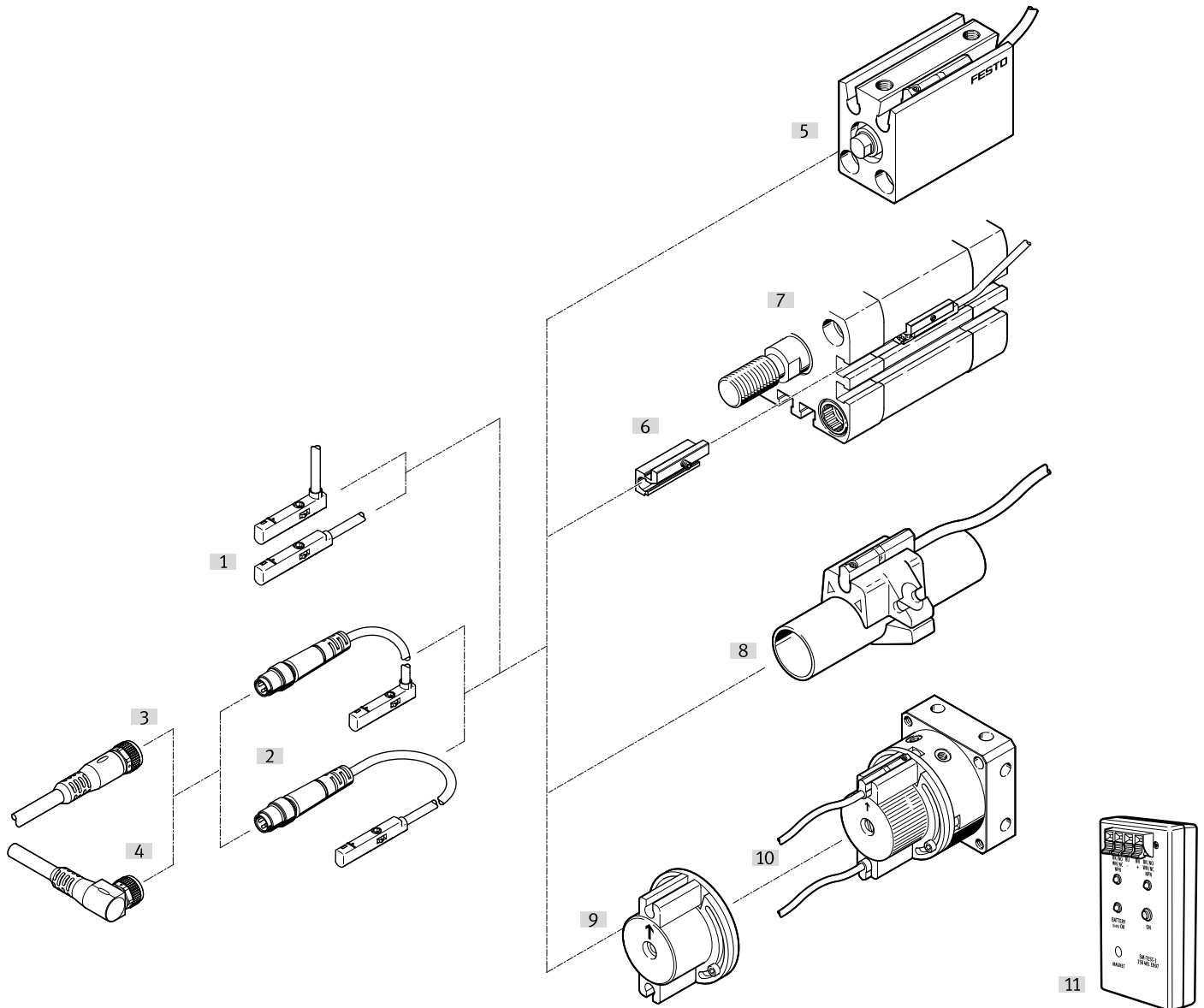

Accessories			→ Page/Internet
Type/order code	Description		
[1] Proximity switch SMT-10M-...-OE	Can be inserted into the slot from above, flush with the cylinder profile, with cable		smt-10m
[2] Proximity switch SMT-10M-...-M...	Can be inserted into the slot from above, flush with the cylinder profile, with cable and plug		smt-10m
[3] Connecting cables NEBU-M...G...	-		12
[4] Connecting cables NEBU-M...W...	-		
[5] Drives with round slot	-		-
[6] Mounting kit SMBN-10	For mounting proximity switches on drives with T-slot		12
[7] Drives with T-slot	-		-
[8] Round cylinder	-		-
[9] Mounting kit WSM-...-SME-10	Mounting kit for mounting proximity switches on semi-rotary drive DSM		12
[10] Semi-rotary drive DSM-B	-		dsm
[11] Sensor tester SM-TEST-1	Checking the function of proximity switches using the built-in voltage source. Adjusting proximity switches on the cylinder.		13

Accessories

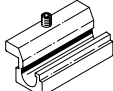
Mounting kit SMBN-10			
	Size	Part no.	Type
	10	537809	SMBN-10

Positioning element SMM			
	Note on materials	Part no.	Type
	RoHS-compliant	547942	SMM-10

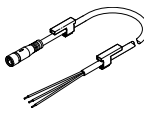
Connecting cable NEBU, connection straight						
	Connection technology left, field device side	Electrical connection 1, cable outlet	Connection technology right, controller side	Cable length [m]	Part no.	Type
	Socket M8x1 A-coded, EN 61076-2-104	Straight	Open end	2.5 m	541333	NEBU-M8G3-K-2.5-LE3
				5 m	541334	NEBU-M8G3-K-5-LE3

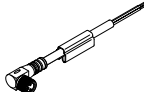
Connecting cable NEBU, angled connection						
	Connection technology left, field device side	Electrical connection 1, cable outlet	Connection technology right, controller side	Cable length [m]	Part no.	Type
	Socket M8x1 A-coded, EN 61076-2-104	Angled	Open end	2.5 m	541338	NEBU-M8W3-K-2.5-LE3
				5 m	541341	NEBU-M8W3-K-5-LE3

Mounting kit for semi-rotary drive DSM			
	Size	Part no.	Type
	10	173206	WSM-8-SME-10
		173207	WSM-10-SME-10
		173205	WSM-6-SME-10

Mounting component SMBK-10				
	Design	Type of mounting	Part no.	Type
	For C-slot	Clamped in C-slot	534255	SMBK-10

Accessories

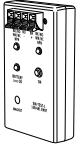
Sensor tester			
	Description	Part no.	Type
	Adjusting proximity switches on the cylinder, Checking the function of proximity switches with the help of the built-in voltage source	158481	SM-TEST-1

Inscription labels			
	Size	Part no.	Type
	4x23 mm	541598	ASLR-L-423

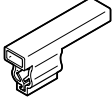
Inscription label holder						
	Length	Width	Height	Size of pack	Part no.	Type
	23 mm	5.4 mm	10.1 mm	100	8078305	NEAU-LH-1